

## Sink Milanello workstation

Kitchen Sinks

Code: 1034 050



### DETAILS

Material AISI 304 stainless steel

Texture Brushed in line

Finish Foster brushed

Edge/Installation Type Flush-mount | Top-mount

Base 80 cm

Dimensions 806 x 520 mm

Width 81 cm

Number of bowls 1 bowl

Bowl dimension 750 x 374 mm

Built-in hole

View technical data sheet

Mixer holes

2 standard holes - 3rd hole on request

Standard fittings

Fixing hooks, gasket, drain, overflow and siphon, boxed packing

Waste fitting

Drain with automatic control SPACE (PUSH)

Drainer

No

## EQUIPMENT

2 x Black grid Milanello 8100

602

1 x Space Push

automatic waste fitting 8407

116

## FEATURES

2nd / 3rd hole available

The sink can be customized with the execution on request of additional holes, usable for double-hole mixers, for remote controlled drains or for the installation of soap dispensers. The positions are marked on the drawings with dotted line holes.

Automatic waste fitting

The waste-fitting with round remote knob is supplied; a practical accessory which makes it unnecessary to get wet in order to drain the water from the bowl.

Diamond-shape bottom

The draining of water is an important feature in a sink, and it's always taken good care of in Foster products. In the bent-welded sinks, which would have a flat bottom, the proper draining is guaranteed by the elegant beveling, which helps the water flow.

Double mixer hole

The large tap counter is already fitted with a series of 2 tap holes. In the second hole it is possible to install the remote control of the automatic drain or, alternatively, a practical soap dispenser.

## High thickness

1mm thick steel. A significant thickness, which guarantees the maximum sturdiness and durability.

---

## Perimetral overflow

The overflow is always a security on the Foster sinks that prevents the overflow of water in case of oversights. The perimeter drain solution improves aesthetics thanks to its square and essential shape.

---

## Save space system

Drain and siphon are designed to leave as much space as possible in the under-sink area, more and more useful today for theseparate waste collection systems.

---

## Space waste fitting

The elegant SPACE steel cap closes the drain and leaves no visible residues collected in the basket below. Space also has a small footprint and allows the optimal use of the under-sink compartment.

---

## Triple recess - sliding accessories

The Foster Milano sink has an ingenious design that makes it simple to use a large set of optional accessories. On the topmost supporting step, the innovative Black grids slide, creating a large and practical surface to rinse food and crockery. The second step is meant to support and allow the sliding of a complete combination of accessories, which make some operations practical and safe: rinse, drain, slice, grate... everything can be done inside the sink. The third supporting step is on the bottom of the bowl. On this step one can rest the Black grids, making it possible to rinse foodstuffs without their coming in contact with the bottom of the sink, which may be dirty.

---

## TECHNICAL DATA

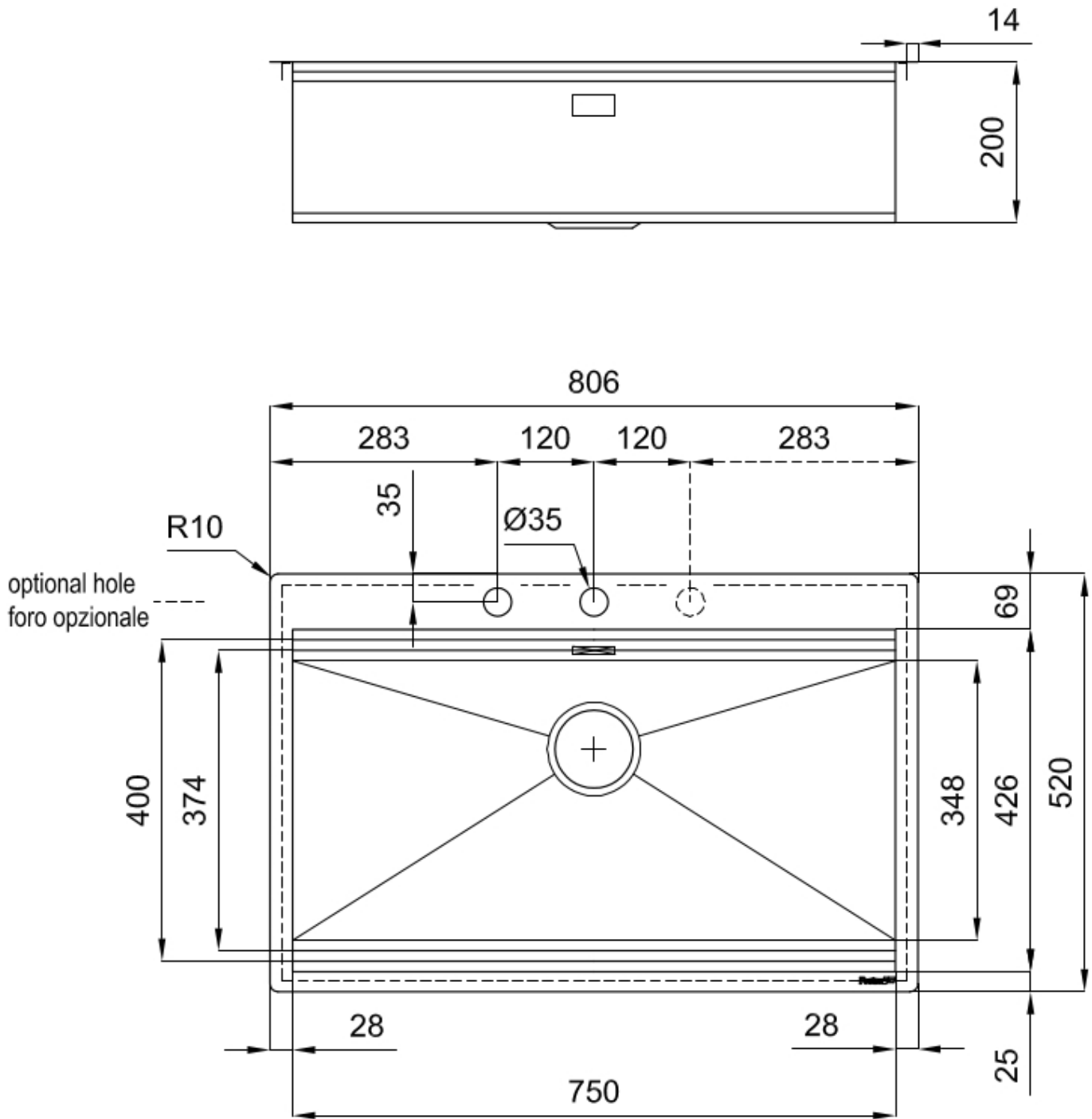

## Milanello Optional accessories / Accessori opzionali

The "rails" system makes it possible to use a combination of numerous accessories. Grids, chopping boards, utensils' ranging system, bowls and containers of different dimensions can be alternated in the workspace with a simple gesture, and can easily be stacked, in order to be on hand at all times.

Il sistema di "corsie" rende possibile l'utilizzo combinato di innumerevoli accessori. Griglie, taglieri, portautensili, vaschette e contenitori di varie dimensioni si alternano nella zona di lavoro con un semplice gesto e possono essere impilati, sempre a portata di mano.

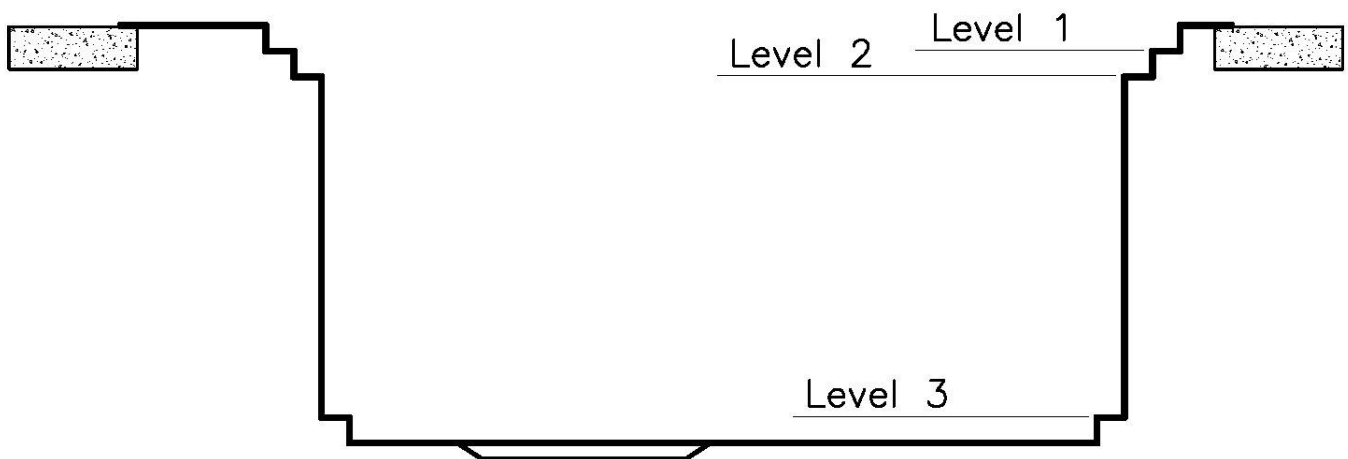

## Milanello Level 1

Compatible accessories/Accessori compatibili:

8631 300  
8657 001  
8644 101  
8644 044  
8100 602

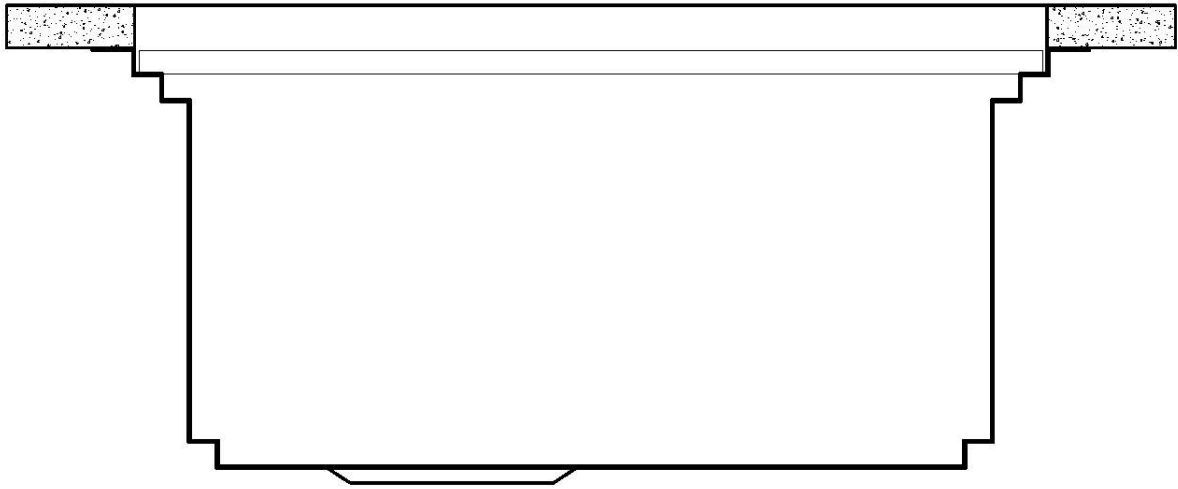

## Milanello Level 2

Compatible accessories/Accessori compatibili:

8156 000

8100 306

8642 004

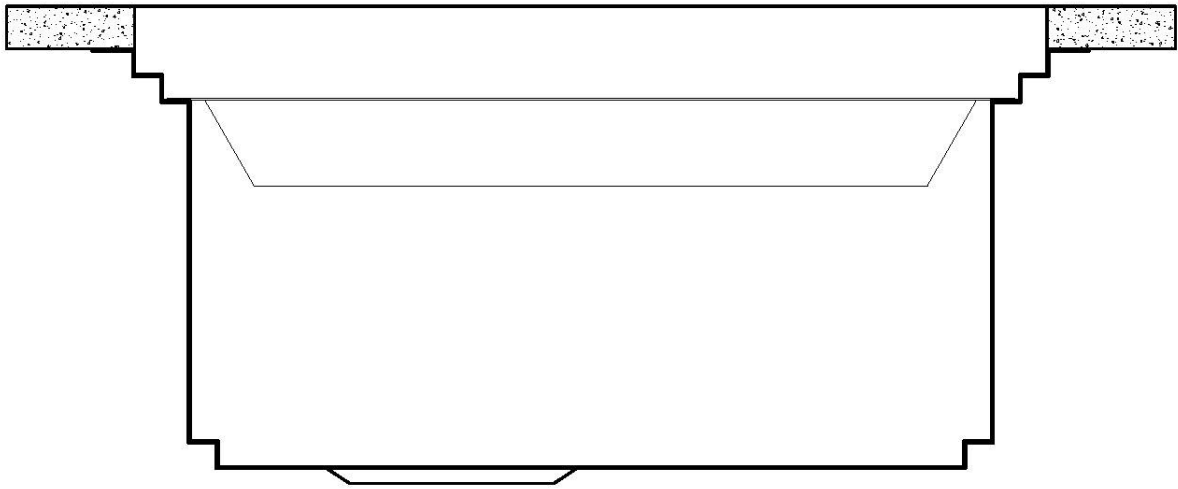

## Milanello Level 3

Compatible accessories/Accessori compatibili:

8100 602

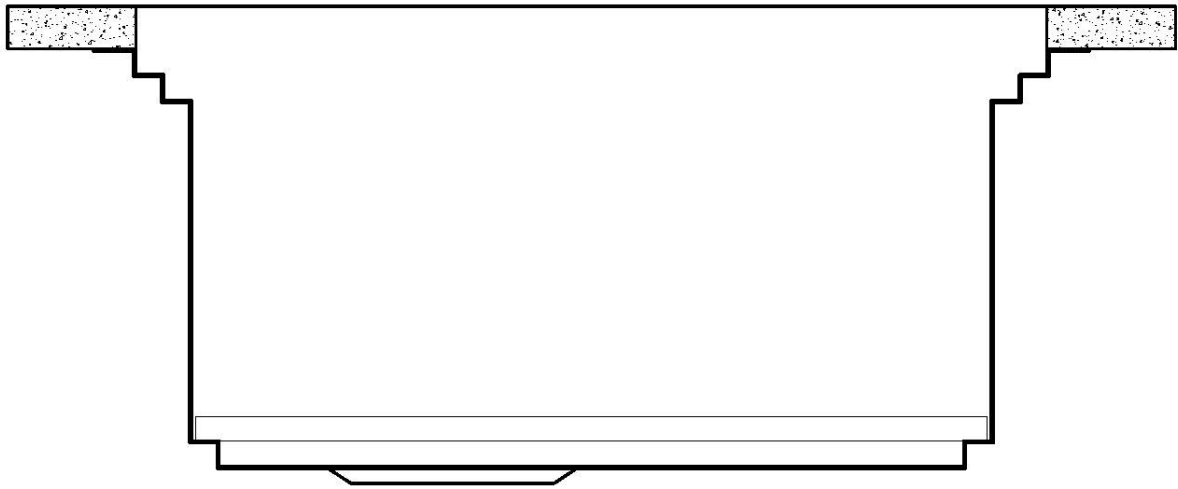



## Lavello MILANELLO cod. 1034/05\*



**FT**



**FTS**

## GALLERY

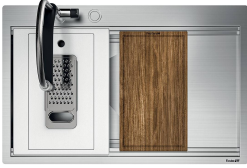
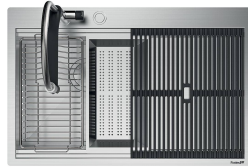
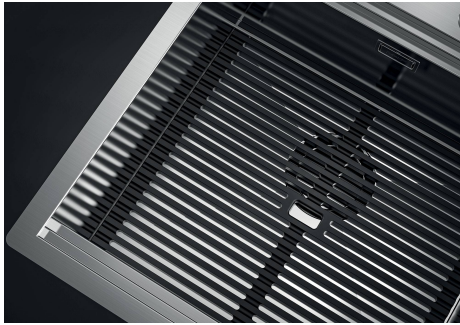

## EQUIPMENT



**Black grid Milanello**  
8100 602



**Space Push automatic waste fitting  
- PP**  
8407 116

## OPTIONAL ACCESSORIES

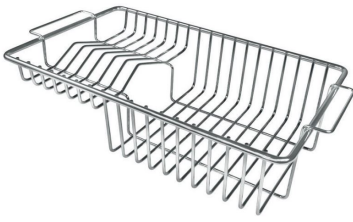

**Stainless steel Plate rack**

8100 306

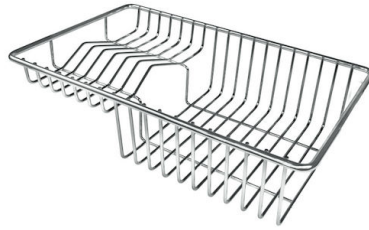

**Stainless steel plate rack**

8100 303

\* only in combination with the accessory  
8644 101



**Glass chopping board**

8631 300



**HPDE Chopping board**

8657 001



**HPDE Twin chopping board**

8644 101



**Graters kit with ring-holder and  
food collection tray**

8159 101

\* only in combination with the accessory  
8644 101



**Walnut-wood chopping board**

8642 004



**Iroko-wood sliding chopping board  
with stainless steel colander**

8644 044



**Stainless steel perforated tray**

8151 000

\* only in combination with the accessory  
8644 101



**Stainless steel perforated tray PVD  
Gun Metal**

8151 006



**Stainless steel perforated tray PVD  
Copper**

8151 008



**Stainless steel perforated tray PVD  
Gold**

8151 009



**Stainless steel perforated tray**  
8156 000

## RECOMMENDED PAIRINGS

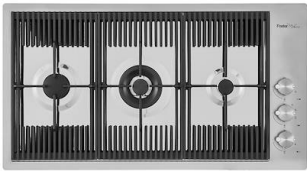

**Cooker hob Milanello**  
7680 000



**Mixer Tap Milanello**  
8425 100